



freepoint

dorigodesign







freepoint

dorigodesign



freeport

dorigodesign



características técnicas

mesa



Tapa elaborada con tablero DM 40mm y chapa natural. Con inserción de cuero y canto de madera 2mm. Laterales realizados con folding DM 40mm con chapa natural y canto de madera 2mm con modelado soforming.

Bandeja pasacables realizada con tablero DM 20mm y chapa natural con canto de madera 0,5mm.

Faldón de tablero DM 40mm con chapa natural y canto de madera 2mm

librería



Cuerpo realizado con tablero AG 20mm con chapa natural y canto de madera 0,5mm.

Puertas de tablero DM 20mm chapado y canto de madera 2mm.

Trasera elaborada con tablero DM 40mm y AG20mm con chapa natural y canto de 2mm-0,5mm madera.

Laterales realizados con folding DM 40mm con chapa natural y canto de madera 2mm con modelado soforming.

Estantes y tapa elaborados con tablero DM 40mm con chapa natural y canto de madera 2mm.

cajonera



Cuerpo realizado con tablero DM 40mm y AG20mm con chapa natural y canto de 2mm-0,5mm madera.

Cajones de madera de haya construido con cola de milano.

Fronteras de tablero DM 19mm y chapa natural con canto de madera 2mm.

herraje

Bisagras de acero con apertura de 100° y montaje en clip con acabado cromado.

Tiradores de DM uñero con acabado poro abierto.

Guías metálicas atornilladas de extracción parcial autofreno de acero inoxidable acabadas con pintura epoxi.

acabados

Acabado poro abierto con una capa de fondo poliacrílico y una capa de acabado de laca de poliuretano de alta resistencia.

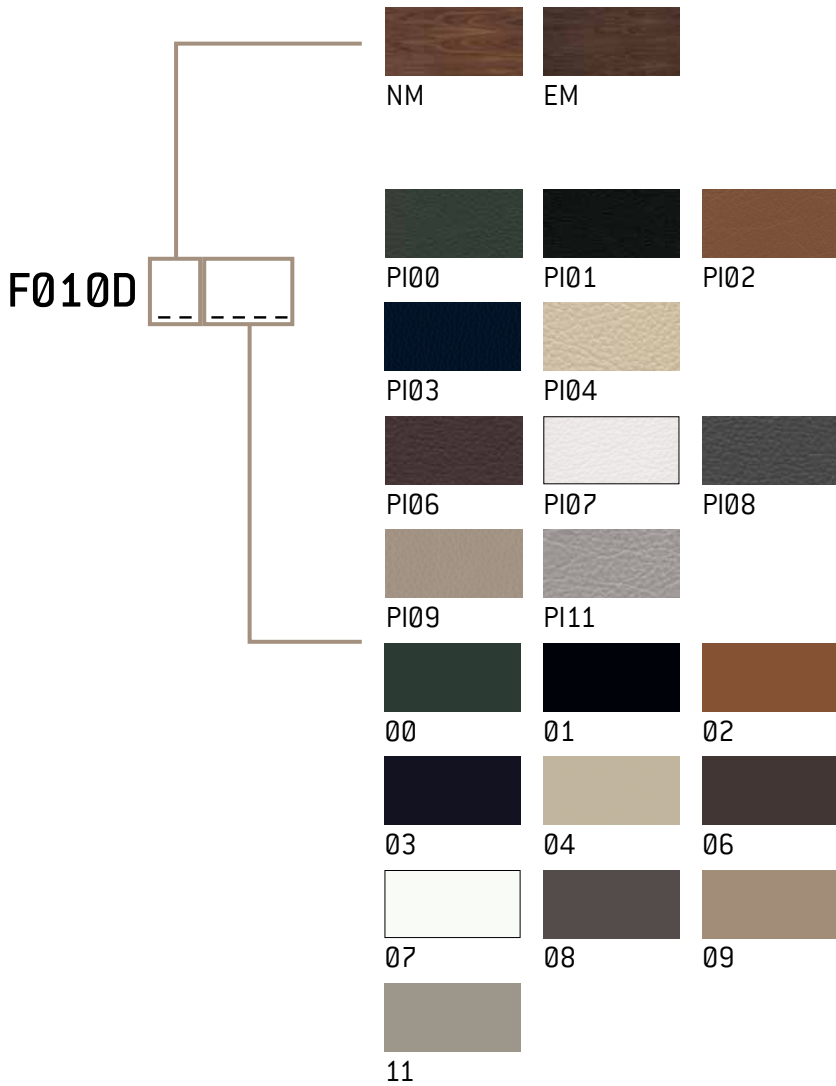

F022NMPI01* =



F010DNMPI01 =



* El interior del mueble auxiliar irá en el mismo color de lacado que la piel.

L x A x H L = largo A = ancho H = alto

NOGAL NATURAL (NM)



NOGAL ESPRESSO (EM)



PIEL VERDE (PI00)

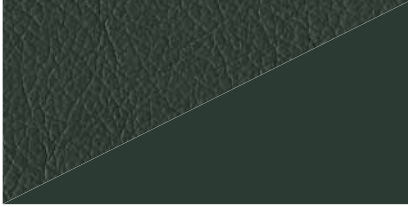

{LM00} LACADO VERDE MATE

PIEL NEGRA (PI01)

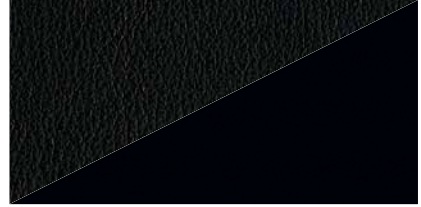

{LM01} LACADO NEGRA MATE

PIEL MARRON CLARO (PI02)

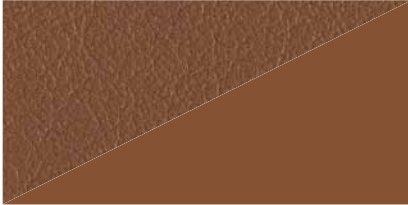

{LM02} LACADO MARRON CLARO MATE

PIEL AZUL (PI03)

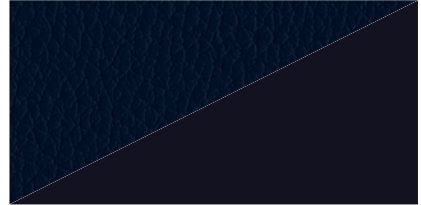

{LM03} LACADO AZUL MATE

PIEL MARFIL (PI04)



{LM04} LACADO MARFIL MATE

PIEL MARRON OSCURO (PI06)

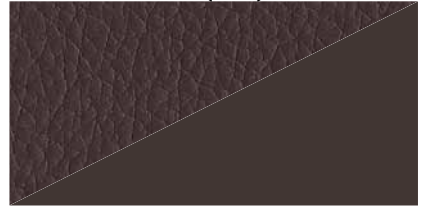

{LM06} LACADO MARRON OSCURO MATE

PIEL BLANCA (PI07)



{LM07} LACADO BLANCO MATE

PIEL ANTRACITA (PI08)

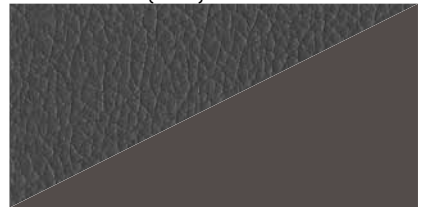

{LM08} LACADO ANTRACITA MATE

PIEL GRIS PIEDRA (PI09)

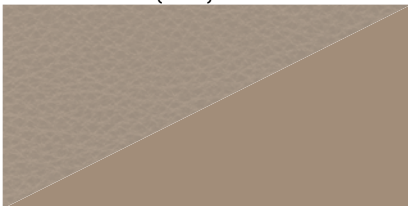

{LM09} LACADO GRIS PIEDRA MATE

PIEL GRIS (PI11)

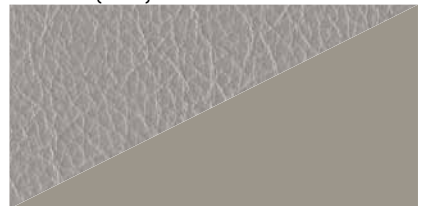

{LM11} LACADO GRIS MATE

	dimensiones (mm.)	código	bultos	kg	m ³
	2340 x 2265 x 750	F012_.....	9	313,50	1,348
	2540 x 2265 x 750	F022_.....	9	327,00	1,339
	2340 x 2265 x 750	F013_.....	9	313,50	1,348
	2540 x 2265 x 750	F023_.....	9	327,00	1,339
	2560 x 2265 x 750	F014_.....	10	336,50	1,211
	2760 x 2265 x 750	F024_.....	10	349,50	1,261
	2560 x 2265 x 750	F015_.....	10	336,50	1,211
	2760 x 2265 x 750	F025_.....	10	349,50	1,261



cajoneras



	dimensiones (mm.)	código	bultos	kg	m ³
	450 x 600 x 660	F230_.....	1	35,00	0,154
	450 x 600 x 660	F240_.....	1	35,00	0,154

	dimensiones (mm.)	código	bultos	kg	m ³
	2085 x 1045 x 750	F010D_.....	5	120,00	0,620
	2085 x 1045 x 750	F010Z_.....	5	120,00	0,620
	2285 x 1045 x 750	F020D_.....	5	127,00	0,645
	2285 x 1045 x 750	F020Z_.....	5	127,00	0,645
	2085 x 1045 x 750	F011D_.....	5	142,00	0,706
	2085 x 1045 x 750	F011Z_.....	5	142,00	0,706
	2285 x 1045 x 750	F021D_.....	5	151,00	0,740
	2285 x 1045 x 750	F021Z_.....	5	151,00	0,740



mesas auxiliares

	dimensiones (mm.)	código	bultos	kg	m ³
	1285 x 640 x 750	F110_....	4	60,50	0,337
	1640 x 785 x 750	F130_....	3	61,00	0,297
	1200 x 600 x 40	F120_....	1	23,50	0,087

	dimensiones (mm.)	código	bultos	kg	m ³
	1240 x 640 x 750	F100_	3	46,50	0,225
	2085 x 1045 x 750	F010D_	5	120,00	0,620
	2085 x 1685 x 750	Total:	8	166,50	0,845

	dimensiones (mm.)	código	bultos	kg	m ³
	1240 x 640 x 750	F101_	3	46,50	0,225
	2285 x 1045 x 750	F021Z_	5	151,00	0,740
	2285 x 1685 x 750	Total:	8	197,5	0,965

mesas de centro



	dimensiones (mm.)	código	bultos	kg	m ³
	685 x 680 x 450	F450_	4	33,50	0,128
	1285 x 680 x 450	F460_	4	47,00	0,168

	dimensiones (mm.)	código	bultos	kg	m ³
	1300 x 750	F150_	2	55,00	0,432
	2400 x 1200 x 750	F170_	4	152,00	0,596
	3000 x 1200 x 750	F180_	4	177,00	0,712

mesa de consejo

	dimensiones (mm.)	código	bultos	kg	m ³
	según proyecto	FP9991	—	—	—

electrificaciones

	dimensiones (mm.)	código	bultos	kg	m ³
	1TSN+1USB CARGA 5V/2A	AUX7002	1	0,20	0,001
	2TSN+1USB CARGA 5V/2A+RJ45	AUX7003	1	0,49	0,001

	dimensiones (mm.)	código	bultos	kg	m ³
--	-------------------	--------	--------	----	----------------



2000 x 600 x 710

F250_.....

5

114,00

0,455



2000 x 820 x 710

F260_.....

6

183,50

0,515

composiciones de librerías

	dimensiones (mm.)	código	bultos	kg	m ³
--	-------------------	--------	--------	----	----------------



1014 x 465 x 850

F312_.....

3

26,00

0,215

unidades

1

3

26,00

0,215



930 x 425 x 710

F302_.....

2

38,00

0,131

unidades

1

2

38,00

0,131





1014 x 465 x 850



Total:

5

64,00



0,346





	dimensiones (mm.)	código	bultos	kg	m ³	
	1945 x 465 x 850	F314_-----	3	47,00	0,285	
	unidades	1	3	47,00	0,285	
	930 x 425 x 710	F302_-----	2	38,00	0,131	
	unidades	2	4	76,00	0,262	
	1945 x 465 x 850					
			Total:	7	123,00	0,547

	dimensiones (mm.)	código	bultos	kg	m ³	
	2880 x 465 x 850	F316_-----	4	86,00	0,371	
	unidades	1	4	86,00	0,371	
	930 x 425 x 710	F302_-----	2	38,00	0,131	
	unidades	3	6	114,00	0,393	
	2880 x 465 x 850					
			Total:	10	200,00	0,764

	dimensiones (mm.)	código	bultos	kg	m ³
	1015 x 445 x 2020	F332_-----	3	35,00	0,216
	unidades	1	3	35,00	0,216
	930 x 425 x 710	F302_-----	3	38,00	0,131
	unidades	1	3	38,00	0,131
	1015 x 445 x 2020	Total:			0,347
			6	73,00	

	dimensiones (mm.)	código	bultos	kg	m ³
	1945 x 445 x 2020	F334_-----	4	61,00	0,350
	unidades	1	4	61,00	0,350
	930 x 425 x 710	F302_-----	3	38,00	0,131
	unidades	2	6	76,00	0,262
	1945 x 445 x 2020	Total:			0,612
			10	137,00	

	dimensiones (mm.)	código	bultos	kg	m ³
	2880 x 445 x 2020	F336_-----	5	111,00	0,500
	unidades	1	5	111,00	0,500
	930 x 425 x 710	F302_-----	3	38,00	0,131
	unidades	3	9	114,00	0,393
 2880 x 445 x 2020		Total:	14	225,00	0,893

	dimensiones (mm.)	código	bultos	kg	m ³
	1015 x 445 x 2020	F342_-----	4	19,00	0,083
	unidades	1	4	19,00	0,083
	930 x 425 x 1590	F304_-----	4	72,50	0,248
	unidades	1	4	72,50	0,248
	nevera	NEV1003	1	13,00	0,150
	unidades	1	1	13,00	0,150
 1015 x 445 x 2020		Total:	8	104,50	0,481